

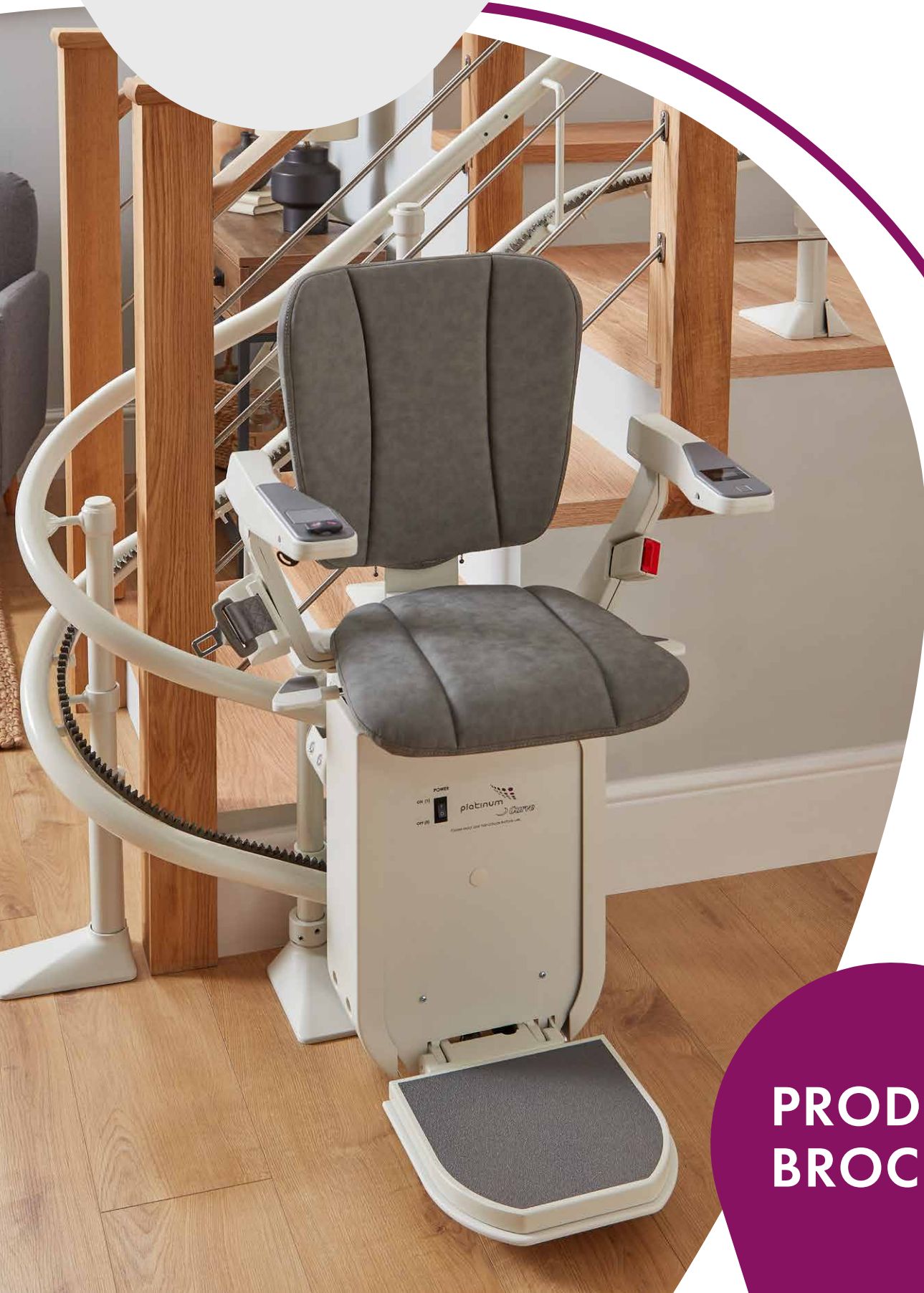

ergo
CURVE
by platinum

platinum
STAIRLIFTS



**PRODUCT
BROCHURE**

THE PLATINUM ERGO CURVE STAIRLIFT

Welcome to the Platinum Ergo Curve stairlift. A smooth and comfortable twin-rail stairlift, ideal for curved staircases with an ergonomic chair that is fully adjustable to you.

Choosing a stairlift can be an overwhelming decision. However, the freedom offered in helping you return to independent living without having to leave the home you love makes it a great choice, providing you with a better quality of life and peace of mind for you, and your loved ones.



WHY CHOOSE A PLATINUM ERGO CURVE STAIRLIFT?



WEIGHT LIMITS

Every Platinum Ergo Curve stairlift is hand-crafted entirely to your home's specification and installed with your individual requirements in mind. The Platinum Ergo Curve twin-rail can navigate the majority of staircases and excels in narrow staircases and tight turns, maintaining a smooth ride throughout. The stairlift has a standard weight limit of 120kg which can be increased to 160kg.



COMFORT

The Platinum Ergo Curve stairlift comes with an ergonomic chair, adjustable arms, backrest, chair pad and footplate providing an easy and comfortable journey for users of every size and shape.

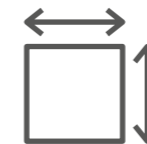

SPACE-SAVING SOLUTIONS

The Platinum Ergo Curve now comes with a space-saving backrest as standard while the Ergo Plus chair pad remains an optional additional space-saving feature. The floor mounted rail, easy foldaway chair, arms and power or lever activated footplate, leaves your stairs free from obstruction.



SAFETY

Safety is paramount, for your peace of mind. Every stairlift is designed and tested to the highest standards (Machinery Directive 2006/42/EC and EN81-40:2020) before it leaves the manufacturing facility to ensure it fits your staircase exactly, and gives you the confidence to live independently.

GET TO KNOW THE PLATINUM ERGO CURVE STAIRLIFT

The Platinum Ergo Curve stairlift offers you the ideal combination of function and comfort, letting you enjoy living in the home you love. Its innovative design means it can fit where other stairlifts cannot.

Tailor-made for you and your home, there are several options that are configured to you and your comfort at the point of order and installation. Here we have detailed these and many other benefits, so you can be confident in your decision that the Ergo Curve is the right stairlift for you.

COMFORT

Choices for an easy and comfortable stairlift

- The Ergo and Ergo Plus chair pad options are designed to make sitting on the chair easy for the user, whatever size or shape.
- The choice of lever-linked or powered footplate means there is no awkward bending to fold up the footplate.
- Powered or manual lever swivel for easy exiting of the chair.
- Can accommodate up to 25st (160kg).

Adjustable arms, backrest, chair pad and footplate.



Direction controls are easy to operate and can be swapped out to a joystick if required.



SAFETY

For you and your loved one's peace of mind

- Easy to use interlocking seat belt for your safety.
- Our stairlifts are battery-powered, in the event of a power cut you can still access your home.
- Automatic stop feature if there is an obstacle on your stairs.
- Text display for real time information, easily visible on the armrest.



Text display.



Remote control to call and park your stairlift at the top or bottom of the stairs.

A space-saving shorter rail.

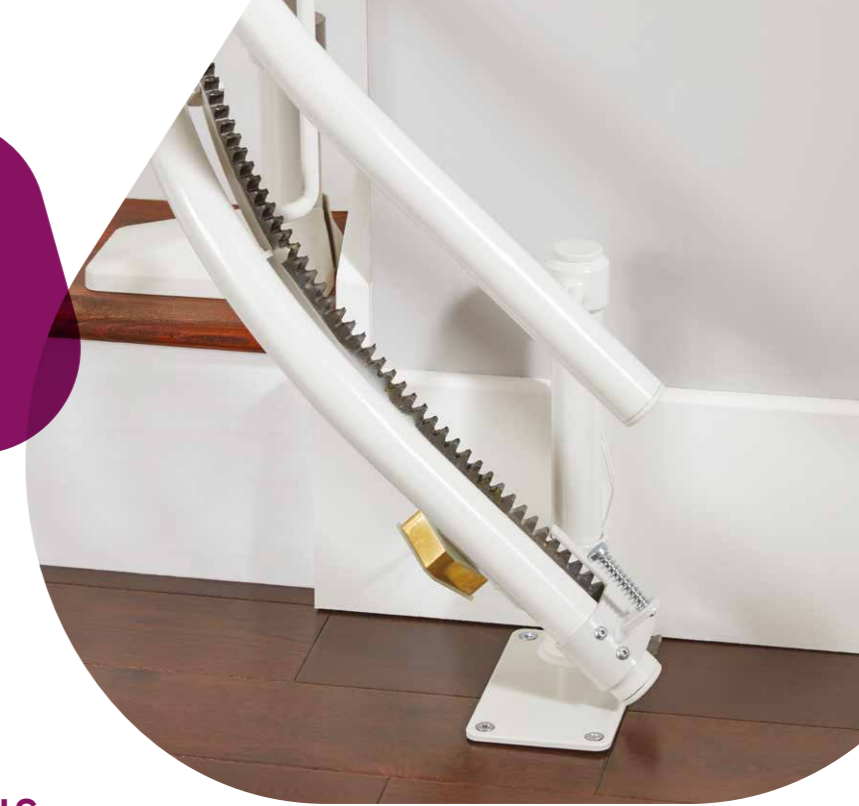

SPACE-SAVING SOLUTIONS

A stairlift that works in any home

- The option of the short 90° or 180° parking bend rail start saves space.
- Foldaway arms, chair and footplate ensure your stairlift leaves your stairs fully accessible for others.



YOUR OPTIONS

The Platinum Ergo Curve stairlift comes with a choice of key features to make it an accessible chair for everyone to use and to fit seamlessly into your home.

The armrests, backrest and chair pad of the Ergo Curve can be adjusted to accommodate the user.

WEIGHT OPTIONS

A choice of weight capacity.

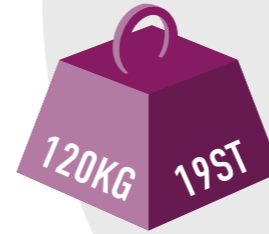

Or



THE CHAIR

The fully adjustable Ergo chair now comes with a space-saving backrest as standard. The optional Ergo Plus chair pad, with its contoured front, is ideal for those with shorter legs or those who have difficulty bending their knees.



Standard Chair pad



The Ergo Plus Chair pad



Power activated or manual chair lever swivel.

THE RAIL

Standard, Short 90° wrap, 90° & 180° wraps and overruns.



Standard Start



Short 90° wrap



90° & 180° wraps



Overruns

THE UPHOLSTERY

Colours to suit your home décor.



Foot Cover



Red



Blue

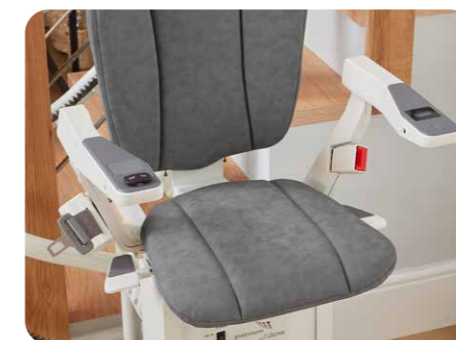

Grey



Beige

THE PLATINUM ERGO CURVE JOURNEY

Six simple steps to help you enjoy your whole home.

- 1 Call your stairlift using the remote control.



- 2 Lower the armrests and the chair pad and put the footplate down with the easy to reach side lever or power footrest button. Your stairlift is ready to use. The screen will display 'Platinum', meaning you are ready to go.

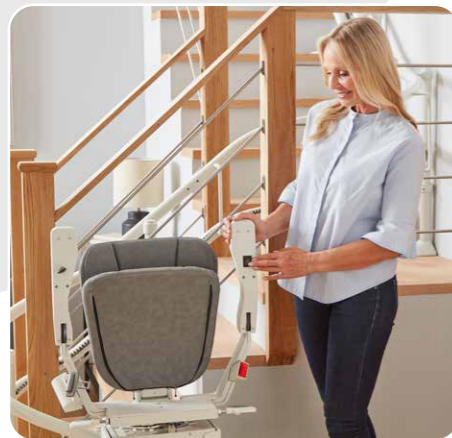

- 3 Your chair will be fully adjusted to your size and shape at installation, so all you need to do is sit comfortably in the chair, engage the seat belt and you are ready.



- 4 To operate your stairlift, simply use the controls in the armrest and lightly press in the direction you wish to travel.



- 5 Once you have arrived, the powered swivel will turn the chair, and when it finishes, you can unbuckle the seat belt and safely step off. If your lift has a manual swivel, use the lever situated under the chair, to swivel the chair.



- 6 On arrival, fold up the arms and chair, and use the footplate lever or button to fold it away.

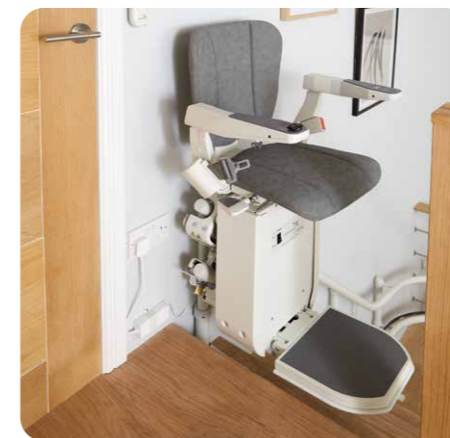

PLATINUM ERGO CURVE SPECIFICATION

SPEED	120mm/s (0.12m/s) Maximum.
DRIVE	250W Rack and Pinion Drive.
WEIGHT CAPACITY	120kg (19St) or 160kg (25St).
STAIRCASE INCLINE	Up to 52°.
OPERATION	Arm mounted rocker / joystick or Radio Frequency remote call and send controls.
CERTIFICATION	BSEN 81-40:2020, Machinery Directive 2006/42/EC, UKCA Supply of Machinery (Safety) Regulations 2008.
RAIL LENGTH	28m maximum rail length.
CHAIR SWIVEL	Manual swivel chair as standard available with lever-linked or powered footplate. Powered swivel chair as an option available with powered footplate. Power swivel available on both Standard and Heavy Duty models. Swivel levers mounted horizontally at both sides of the chair.
FOOTPLATE	Manual lever-link on carriage or powered option.
CHAIR HEIGHT	Ergo chair height 484mm.
CHAIR VARIATIONS	Fully adjustable Ergo Chair with the option of the Ergo Plus chair pad. (Space saving back now comes as standard).
SAFETY	Safety edges on footplate and carriage. Over-speed governor. Electro-magnetic motor brake. Retractable reel seat belt. Interlock chair swivel.

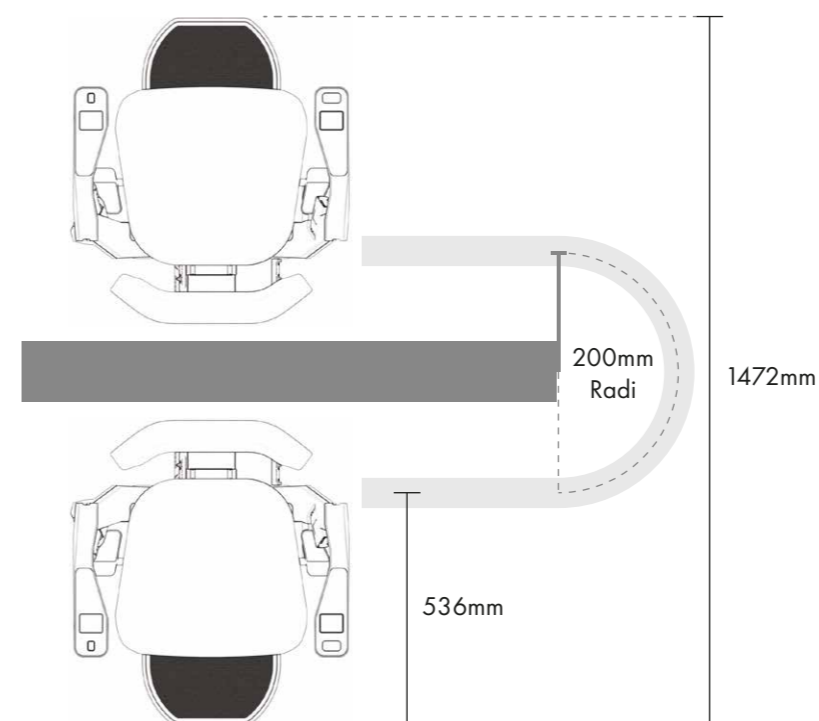
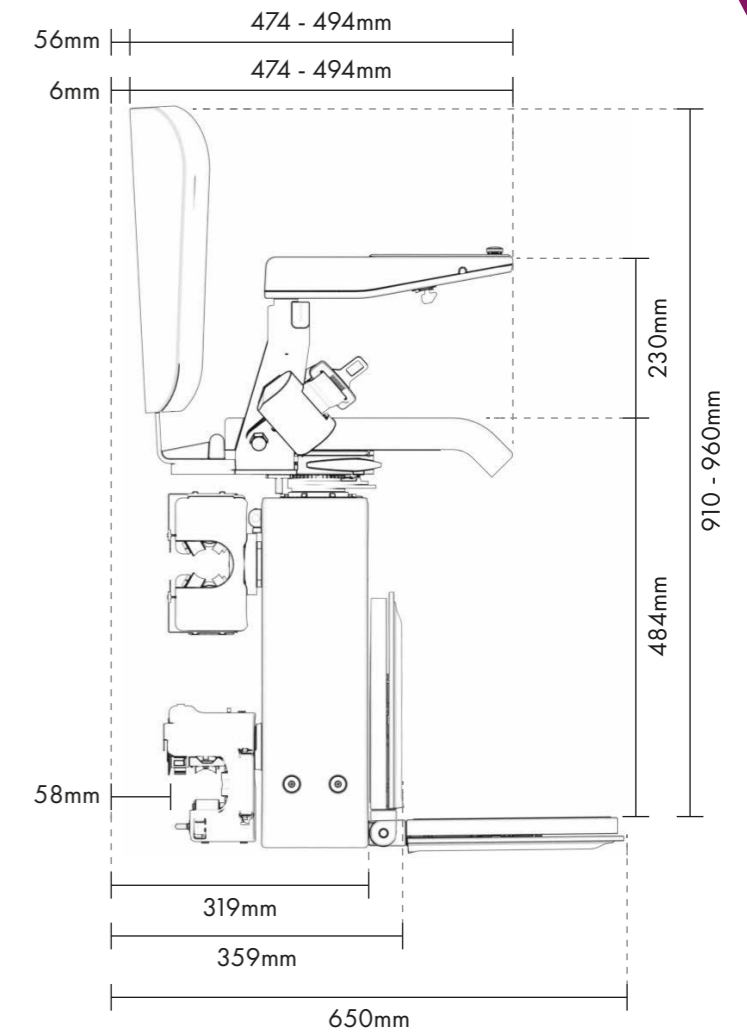
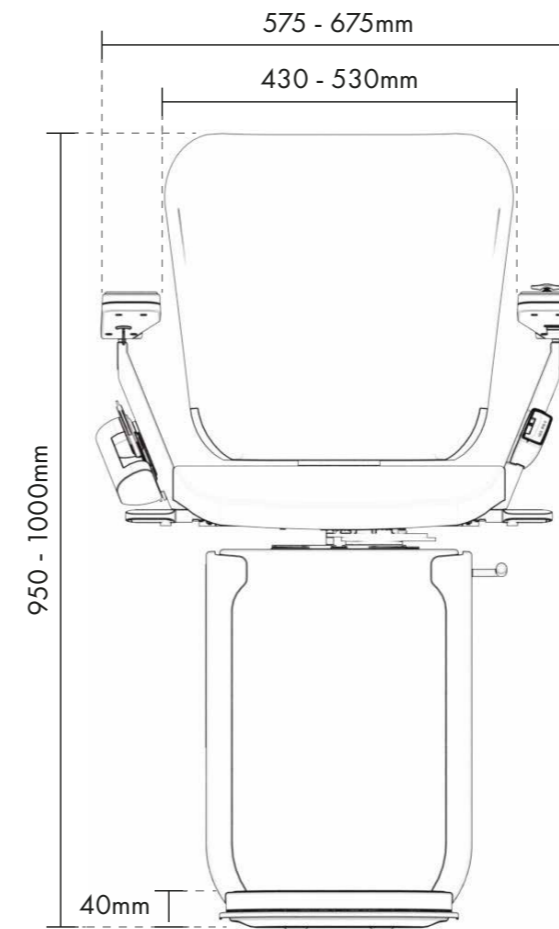



WHY CHOOSE PLATINUM?

Platinum Stairlifts are a British manufacturer, located in Yorkshire. We have been a provider of high-quality stairlifts since 1996.

Committed to the highest level of quality, safety, comfort and reliability. Every stairlift is tested in our manufacturing facility to the highest standards prior to delivery and comes with a personalised signed certificate of quality.

Platinum Stairlifts work closely with an Approved Partner Network across the world. You can be assured that your stairlift provider is confident in our quality product and is fully-trained and supported by us to provide the best solution for you.

“When our customers need a stairlift, time is of the essence. This is why we choose to work with Platinum Stairlifts. They provide a quality product for staircases of all shapes and sizes, and with a great turnaround time. Finally, if there are ever any issues, they are always on hand to support us and resolve things quickly.”

Platinum Partner - March 2023





Quality | Reliability | Partnership | Innovation | Caring

Platinum Stairlifts Ltd, Unit 10 Crosshills Business Park,
Keighley, West Yorkshire, BD20 7BW
+44 (0) 1535 631 177

www.platinumstairlifts.com | enquiries@platinumstairlifts.com

Company Registration Number: 3179671 VAT Registration Number: 288337264

Designed to comply with EN81-40:2020. For patent information, please visit www.platinumstairlifts.com/patent



Numéro d'enregistrement de l'entreprise: 3179671
Numéro d'enregistrement TVA: 288337264
Certifié conforme à BSEN81-40:2008 et Euro Pat App 3478618
Pour obtenir des informations sur les brevets, veuillez visiter
www.platinumstairlifts.com/patent



Firmenregistrierungsnummer: 3179671
Umsatzsteuer-Identifikationsnummer: 288337264
Zertifiziert nach EN81-40:2020 und Euro Pat App 3478618
Informationen zum Patent finden Sie unter
www.platinumstairlifts.com/patent



Numero di registrazione della società: 3179671
Numero di partita IVA: 288337264
Testato e certificato in modo indipendente per la conformità a
EN81-40:2020 e Euro Pat App 3478618
Per informazioni sui brevetti si prega di visitare
www.platinumstairlifts.com/patent



Número de registro de empresa: 3179671
Número de IVA: 288337264
Probado y certificado de forma independiente para cumplir con
EN81-40:2020
Para obtener información sobre patentes, visite
www.platinumstairlifts.com/patent

